

LED Mosaic Modular Lighting System - Model 92

PRODUCT INFORMATION

Description	24V LED ECE Cornering Light (Bulk)
Height	54.80 mm / 2.16 in
Width	83.80 mm / 3.3 in
Depth	76.70 mm / 3.02 in
Shape	Rectangular
Outer Lens Material	Polycarbonate
Outer Lens Color	Clear
Housing Material	Die-Cast Aluminum
Housing Color	Black
Bezel Color	N/A
Minimum Operating Temperature	-40 °C / -40 °F
Maximum Operating Temperature	65 °C / 149 °F
Mating Connector	JAE MX19A003S51 2 Pos
Product Weight	0.60 lbs / 0.27 kgs

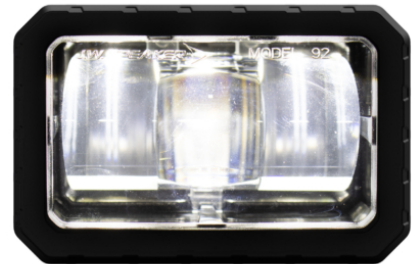

PRODUCT DIMENSIONS

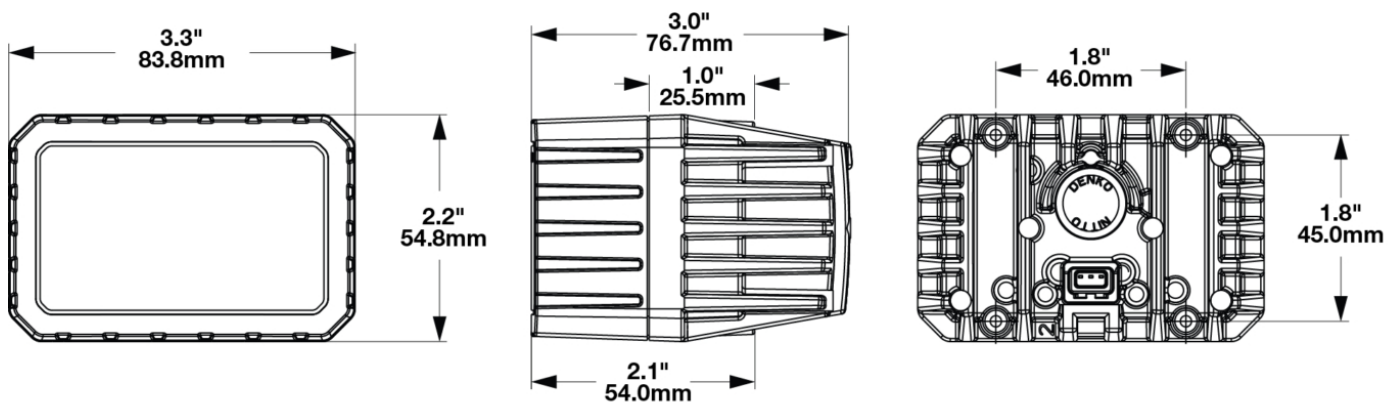

Print date: 2025-02-05

© 2025 J.W. Speaker Corporation • Germantown, WI U.S.A.
 www.jwspeaker.com • speaker@jwspeaker.com • 262.251.6660

LED Mosaic Modular Lighting System - Model 92

ELECTRICAL SPECIFICATIONS

Input Voltage	24V DC
Operating Voltage	18-30V DC
Red Wire	Power
Black Wire	Ground
Current Draw	0.66A @ 24V DC (Cornering)

REGULATORY STANDARDS COMPLIANCE



ECE Reg 149 - K
IEC IP69K

IEC IP67
SAE J852

PHOTOMETRIC SPECIFICATIONS

Raw Lumen Output	2080 Cornering
Effective Lumen Output	725 Cornering
Candela Output	10200
Nominal LED Color Temperature	5700 K
Beam Pattern(s)	Forward Lighting - Cornering

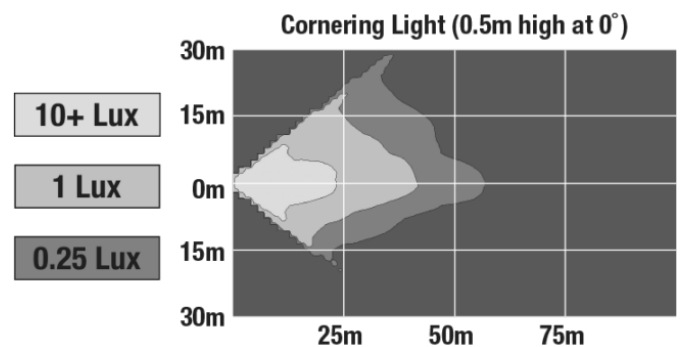

APPLICATIONS

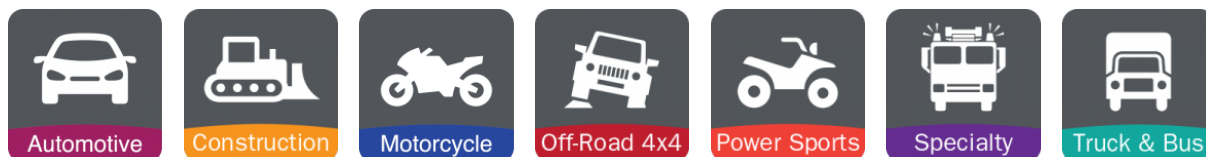

Print date: 2025-02-05

© 2025 J.W. Speaker Corporation • Germantown, WI U.S.A.
www.jwspeaker.com • speaker@jwspeaker.com • 262.251.6660

LED Mosaic Modular Lighting System - Model 92

INSTALLATION & APPLICATION INFORMATION

European cornering light.

PRODUCT WARNINGS

For California residents:

⚠ **WARNING:** Cancer and reproductive harm - www.P65Warnings.ca.gov.

⚠ **AVERTISSEMENT:** Cancer et effet nocif sur la reproduction - www.P65Warnings.ca.gov.

ACCESSORIES



Part Number
8200831

Mounting Hardware Kit
for Mosaic



Part Number
8201031

Pedestal Mount Kit for
Mosaic



Part Number
8201041

Tall Mounting
Hardware Kit for
Mosaic

Print date: 2025-02-05

© 2025 J.W. Speaker Corporation • Germantown, WI U.S.A.
www.jwspeaker.com • speaker@jwspeaker.com • 262.251.6660

LED Mosaic Modular Lighting System - Model 92

RELATED PRODUCTS



Part Number
0347971
12-24V LED DOT/ECE
DI & DRL Light



Part Number
0347972
12-24V LED DOT/ECE
DI & DRL Light (Bulk)



Part Number
0556821
12V LED SAE/ECE Fog
Light



Part Number
0556831
12V LED SAE High
Beam & DRL Headlight

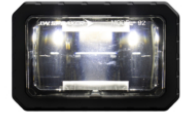

Part Number
0556832
12V LED SAE High
Beam & DRL Headlight
(Bulk)

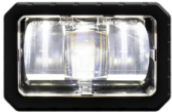

Part Number
0557941
12V LED SAE/ECE
Cornering Light

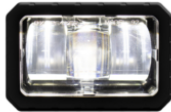

Part Number
0557942
12V LED SAE/ECE
Cornering Light (Bulk)



Part Number
0558321
12V LED SAE/ECE
Symmetric Low Beam
Headlight